



Application Instructions

ENGLISH

IMPORTANT MESSAGE • PLEASE READ! IKO assumes no responsibility for leaks or defects resulting from improperly installed shingles, improper preparation of the surface to be roofed over, or failing to provide proper ventilation in accordance with local building codes. Use caution when stacking bundles on sloped roofs.

ROOF SLOPE / ROOF DECKS: Never apply asphalt shingles to roof slopes less than 2:12. For slopes 2:12 to less than 4:12 (LOW SLOPE), see special underlayment requirements outlined below. We do not recommend the application of our roof shingles directly to any type of roof insulation, including perlite or fiberglass, foam, wood fiber, or similar products. Further, the application of our roofing shingles directly over any structural decks including gypsum, nailable concrete, or similar products (without our prior approval) will void the warranty.

STEPS 1-3

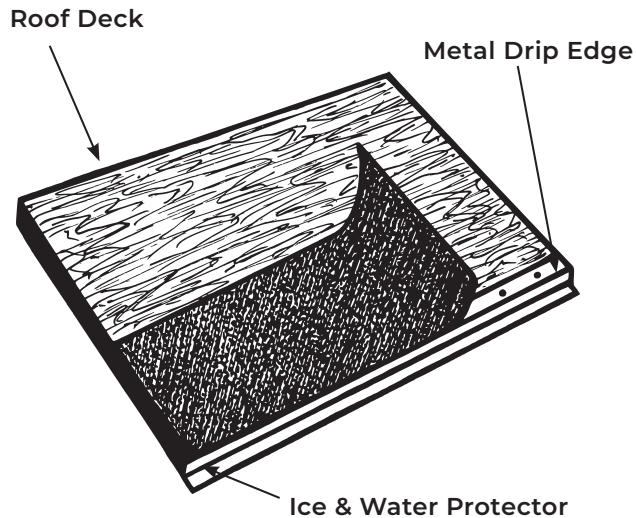

STEP 1:

PREPARE THE ROOF DECK: Deck must be smooth, firm, clean, dry and securely nailed. Wood panel decking is to be exterior grade, conforming to building code requirements. Panels are to be 3/8" min. thick plywood, or 7/16" min. thick non-veneer. The installation of asphalt shingles on dimensional lumber (including shiplap/board decks) is not recommended as it may potentially cause buckling problems, which are not covered by our Limited Warranty.

STEP 2:

APPLY DRIP EDGE ALONG EAVES: Apply metal drip edges directly to the deck along the eaves, spacing nails approximately 12" apart.

STEP 3:

EAVE PROTECTION: Apply eave protection, such as IKO StormShield® Ice and Water Protector, as per building code requirements and manufacturer's instructions, overhanging eaves by 1/4" to 3/4" and extending up the roof at least 24" beyond the interior wall line. NOTE: IKO recommends the use of eaves protection in all situations, however, if no ice and water protector is required by your local code or standard, then alternately apply first course of underlayment overhanging the eaves by 1/4" to 3/4".

STEPS 4-5

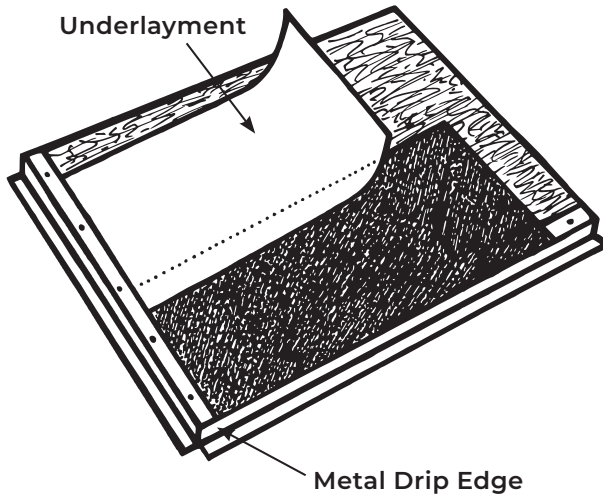

STEP 4:

UNDERLAYMENT: Apply underlayment, either asphalt saturated felt or synthetic underlayment, such as IKO's Stormtite™, in horizontal courses up the roof with 2" side laps and 4" end laps. Trim the sheet to fit the final course at the peak. One layer of asphalt saturated felt (or equivalent) is required over the entire deck to qualify for an ASTM E108 Class A fire rating or which may be required per the local building code.

LOW SLOPE: For roof slopes less than 4:12 down to 2:12 apply underlayment in successive courses by overlapping the preceding sheet by 19" with 4" end laps. Alternately, apply a single layer of Ice and Water Protector over the entire deck per manufacturer's instructions.

NOTE: SHINGLES APPLIED ACCORDING TO THESE INSTRUCTIONS ON SLOPES 3:12 TO 4:12 WILL BE WARRANTED FOR THE FULL WARRANTY TERM. SHINGLES ON SLOPES 2:12 TO 3:12 WILL BE WARRANTED FOR 12 YEARS.

STEP 5:

APPLY DRIP EDGE AT THE RAKES: Apply metal drip edges on top of any underlay along rake edges, spacing nails approximately 12" apart.

STEPS 6-7

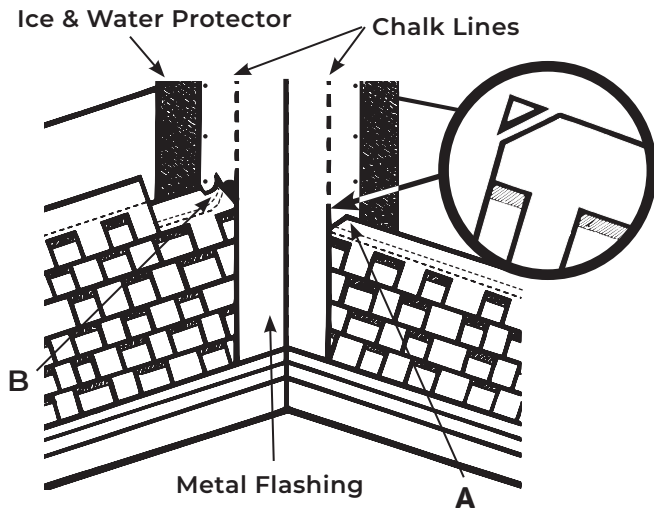

STEP 6:

INSTALL FLASHING: Corrosion-resistant flashing must be used to help prevent leaks where a roof meets a wall, another roof, a chimney or other objects that penetrate a roof. Flashing shall conform to the requirements of applicable building code and good roofing practice.

STEP 7:

INSTALL OPEN METAL VALLEYS: Metal valleys are recommended. (Closed valley applications are acceptable but not recommended. Please see Limited Warranty for details.) Complete valley flashing before shingles are applied. Center a 36" wide strip of Ice & Water Protector in the valley and then fasten at the edges with only enough nails to hold in place. Center a minimum 24" wide, minimum 28 gauge pre-finished/galvanized metal valley liner in the valley, and fasten the edges with only enough nails to hold in place. Snap two chalk lines the full length of the valley, 6" apart at the top and increasing in width 1/8" per foot towards the bottom. When the shingles are being applied, lay them over the valley flashing, trim the ends to the chalk line, and cut a 2" triangle off the corner to direct water into the valley (A). Embed the valley end of each shingle into a 3" band of asphalt plastic cement (B). Do not place a nail in the shingle closer than 2" from the chalk line.

STEP 8

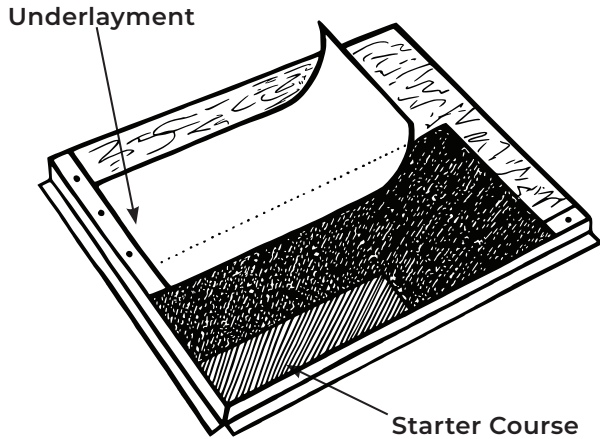

STEP 8:

INSTALL STARTER COURSE: IKO recommends using Leading Edge Plus™ Starter Shingles. Fold the Leading Edge Plus shingle along the perforation to separate. Cut the first starter shingle in half. Beginning at the left corner of the roof, start the eaves course by positioning one of the halves granule side up with the sealant adjacent to the eaves. It should overhang the eaves and rake edge by 1/4" to 3/4". Fasten the half-length shingles with nails located about 3" from the eaves edge and 1" in from each end with a third in the center. Complete the eave and rake starter courses with full lengths of starter shingles maintaining a 1/4" to 3/4" overhang, and fastening with four nails per shingle.

STEPS 9-13

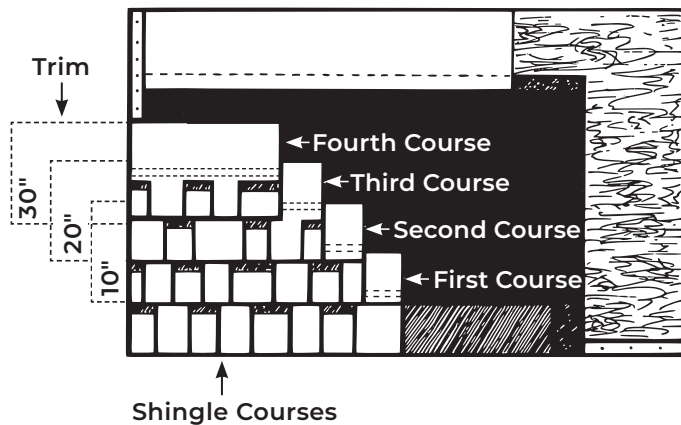

STEP 9:

INSTALL THE FIRST COURSE: Start with a full length shingle applied flush with starter course at rake and eave. Use four nails per shingle placed as shown below. After the first shingle in the course is installed, continue with full length shingles to complete the first course, trimming the last shingle so that it matches the overhang of the starter course below.

IMPORTANT! — PROPER NAILING | IMPORTANT!

Standard Application
Requires **4 Nails/Fasteners**

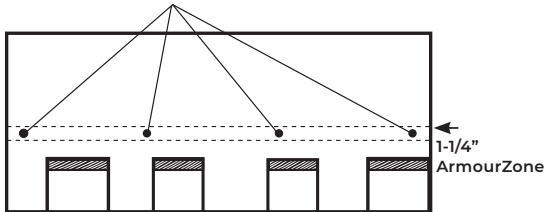

Apply Roofing Cement CAUTION: Excessive Use of Roofing Cement Can Cause Shingles to Blister.

Steep Slope/High Wind Applications
Requires **6 Nails/Fasteners**

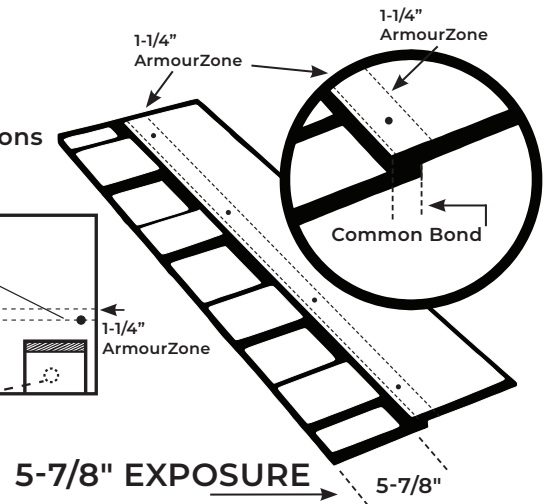
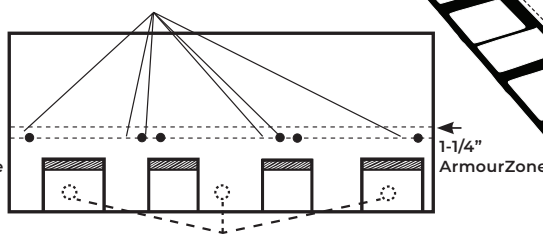

PROPER NAILING:

NAILING ON STEEP SLOPES: On slopes of 21:12 (60°) or more, use six nails per shingle placed as shown below.
NOTE: Each nail MUST penetrate both layers of the shingle by nailing into the lower nail line only. Ensure that no nail is within 2" of a joint/cutout of the underlying shingle.
Seal down each shingle at time of application with three 1" diameter spots of roofing cement placed under the shingle 2" above the bottom edge and equally spaced along the shingle. Use roofing cement sparingly, as excessive amounts may cause blistering.

STEP 10:

CHALK LINES: To aid in alignment, snap horizontal chalk lines. Exposure is 5-7/8".

STEP 11:

INSTALL THE SECOND, THIRD AND FOURTH COURSES:

Trim off 10", 20", and 30" respectively, from the left end of the starting shingle and apply to overhang rake edge by 1/4" to 3/4". Continue each course across the roof with full shingles butting ends loosely. Align the bottom edge of the shingles with the tops of the saw teeth of the shingles in the underlying course. Note: Other offsets between 6" – 10" may be used. These alternative offsets will not adversely affect the applicable provisions of IKO's Limited Warranty, but may in some instances result in aesthetic issues.

STEP 12:

INSTALL THE FIFTH AND SUCCEEDING COURSES:

Repeat the sequence of the first four courses up the roof. For maximum wind protection, cement shingles at rake edges.

STEP 13:

MANUALLY SEAL SHINGLES (IF NEEDED): Shingles should seal to the underlying course when the factory applied asphalt sealant is sufficiently warmed by the heat of direct sunlight. When conditions such as cool weather, high winds or blowing dust might limit the effectiveness of the sealing strip, please follow the steep slope requirements above and manually apply roofing cement.

STEP 14:

INSTALL HIPS AND RIDGES: IKO recommends its pre-cut Hip and Ridge products, or pre-formed high profile IKO UltraHP. For IKO pre-cut Hip and Ridge products bend each piece over the hip or ridge, and nail per instructions on the wrapper. The final shingle should be set in roofing cement and the exposed nail heads of this shingle should be covered with roofing cement. For IKO UltraHP, follow the instructions on the box. Prior to application in cold weather, store hip and ridge shingles in a heated area to allow for easier bending.

IMPORTANT MESSAGE • PLEASE READ!

Shingles should seal to the underlying course when the factory applied asphalt sealant is sufficiently warmed by the heat of direct sunlight. When application conditions might limit the effectiveness of the sealing strip, such as in cool weather or in areas subject to high winds or blowing dust, shingle adherence should be ensured through manual sealing as described above. • Starter strip shingles must be used at all eaves, and • Manual sealing is not required in the state of Florida.

IMPORTANT: FOR ALL APPLICATIONS IT IS CRITICAL TO USE THE NAIL LINES AS A GUIDE AND POSITION NAILS AS DIRECTED IN THESE INSTRUCTIONS. IMPROPER NAILING CAN VOID IKO'S LIMITED WARRANTY.

FASTENERS: Nails must be 11 or 12-gauge roofing nails, corrosion-resistant, with at least 3/8" heads, and at least 1" long. For decks 3/4" thick or thicker, nails must go at least 3/4" into the deck. On thinner decks, nails must go at least 1/8" through the deck.

